

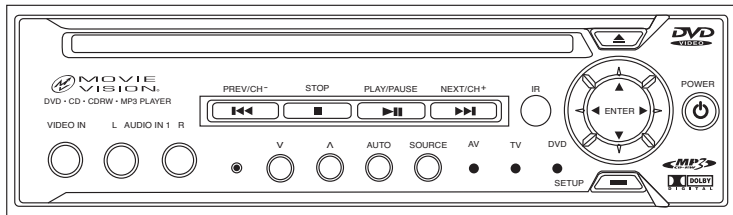

**MOVIE
VISION**

Owner's Manual

Mobile DVD Player



Model: MV-DVD-PL5

For operational or technical assistance, after reading this manual,
please call us toll free at (800) 638-3600.

Features

- Compatible with PAL and NTSC Systems
This player can play discs recorded in either PAL or NTSC format.
- CD, DVD, CD-R, CD-RW, MP3 Compatible.
- L/R stereo analog audio outputs for connection to existing head unit aux. inputs. Video output is composite video.
- Supplied Remote Features: multi-language audio-track/subtitle, multi-angle, plus all basic functions.
- Built-In PLL TV Tuner

Use this Product Safely

Driving

Be aware of road and traffic conditions. Keep the volume at a low level.

Moisture

Do not expose the product to water or excessive moisture. This could cause electrical shorts, fire or other damage.

Parking

Parking in direct sunlight can produce very high temperatures inside your vehicle. Give the car interior a chance to cool down before starting playback.

Proper Power Supply

This product is designed to operate with a 12 Volt DC, negative ground battery system.

Protecting the Disc Mechanism

Avoid inserting any foreign objects into the slot of this player. Failure to observe this precaution may cause malfunction of this unit.

Repairs

Contact our customer service representatives. Do not attempt to disassemble or adjust this product yourself.

Installation

The unit should be installed in a horizontal position with the front end up at a convenient angle of not more than 30°.

Contents

Safety Information	3	On-Screen Display Function	12-13
Disc Notes	4	PAL/NTSC System Selection	13
DVD Player (Front & Back View)	7	Random Playing	14
Installation	6	Zoom Function	14
Electric Connection	7	Special Function for DVD	14
Remote Control	8	Data Disc and Audio CD Play	16
Location of Keys/Preparing Remote	8	Setup	17
Remote Control Functions	9	Language Setup	17
Basic Operation	10	Display Setup	18
Turning the Unit On	10	Audio Setup	18
Basic Play	10	Lock Setup	18
DVD Video Menu	11	Others Setup	18
Mode Selection	11	TV Operation	20
Reset Function	11	Specifications	22
Last Play Memory	11	Troubleshooting	23
Advanced Operation	12	Replacement Parts	23
Repeat Play	12	Warranty	24
PBC Menu Playback VCD	12		

Safety Information

CAUTION:

MOBILE DVD PLAYER IS A CLASS I LASER PRODUCT. HOWEVER, THIS MOBILE DVD PLAYER USES A VISIBLE/INVISIBLE LASER BEAM WHICH COULD CAUSE HAZARDOUS RADIATION EXPOSURE IF DIRECTED. BE SURE TO OPERATE THE MOBILE DVD PLAYER CORRECTLY AS INSTRUCTED. USE OF CONTROLS OR ADJUSTMENTS OR PERFORMANCE OF PROCEDURES OTHER THAN THOSE SPECIFIED HEREIN MAY RESULT IN HAZARDOUS RADIATION EXPOSURE. DO NOT OPEN COVERS AND DO NOT REPAIR YOURSELF. REFER SERVICING TO QUALIFIED PERSONNEL.

WARNING:

- TO REDUCE THE RISK OF FIRE OR ELECTRIC SHOCK, DO NOT EXPOSE THIS EQUIPMENT TO RAIN OR MOISTURE.
- TO REDUCE THE RISK OF FIRE OR ELECTRIC SHOCK AND ANNOYING INTERFERENCE, USE ONLY THE RECOMMENDED ACCESSORIES.
- THIS DEVICE IS INTENDED FOR CONTINUOUS OPERATION.

This product incorporates copyright protection technology that is protected by method claims of certain U.S. patents and other intellectual property rights owned by Magnadyne Corporation and other rights owners. Use of this copyright protection technology must be authorized by Magnadyne Corporation and is intended for home and other limited viewing uses only unless otherwise authorized by Magnadyne Corporation. Reverse engineering or disassembly is prohibited.

Region Management Information:

This Mobile DVD Player is designed and manufactured to respond to the Region Management Information that is recorded on a DVD disc. If the Region number described on the DVD disc does not correspond to the Region number of this Mobile DVD Player, this Mobile DVD Player cannot play this disc.

Disc Notes

Disc Formats Supported by this Player:

	DVD 12 cm disc (Single-sided disc only)
	Video CD 12 cm disc
	CD 12 cm disc
	MP3 12 cm disc

Note: A disc may become somewhat scratched (although not enough to make it unusable) depending on handling and conditions in the usage environment.

Discs which Cannot be Played with this Player:

- DVD-ROM
- DVD-R/DVD-RAM
- CDV
- CD-G

Handling and Cleaning

- Dirt, dust, scratches and warping disc will cause non operation.
- Do not place stickers on disc or scratch disc.
- Do not warp discs.
- A disc should always be kept in its case when not in use to prevent damage.
- Do not place discs in the following places:
 1. Direct sunlight
 2. Dirty, dusty and damp areas
 3. Near car heaters
 4. Car seats or dashboard

Disc Cleaning

Use a dry soft cloth to wipe the surface. If the disc is quite dirty, use a soft cloth slightly moist with isopropyl (rubbing) alcohol. Never use solvents such as benzine, thinner or conventional record cleaners as they may mar the surface of the disc.

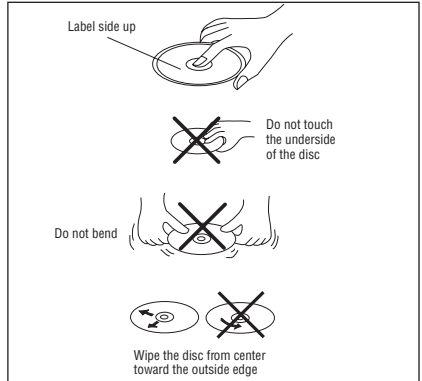

Preparing New Discs with Rough Spots

A new disc may have rough edges on its inside and outside edges. If a disc with rough edges is used, the proper setting will not be performed and the player will not play the disc. Therefore, remove the rough edges in advance by using a ball point pen or pencil as shown. To do this, press the side of the pen or pencil against the inside and outside edges of the disc.

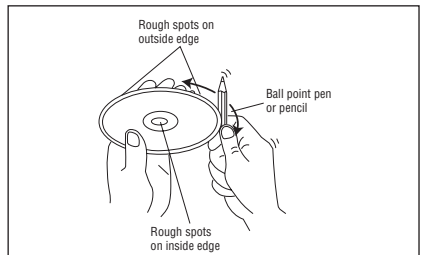

DVD Unit Functions

Front View

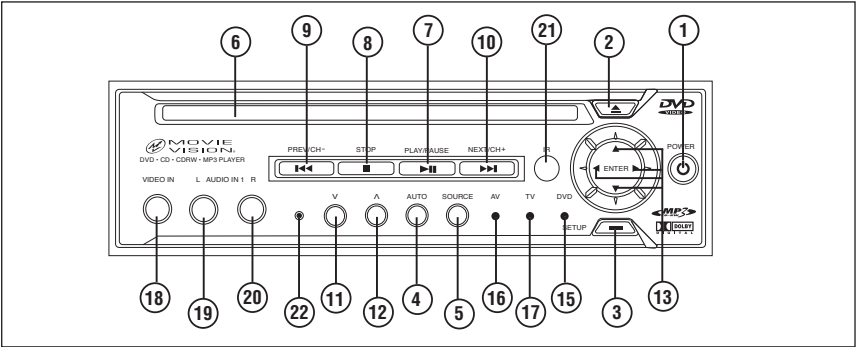

- | | |
|------------------|-----------------------------|
| 1. POWER | 12. VOLUME UP |
| 2. EJECT | 13. , , , Cursor buttons |
| 3. SETUP | 14. ENTER |
| 4. AUTO | 15. Indicator Light for DVD |
| 5. SOURCE | 16. Indicator Light for AV |
| 6. Disc Slot | 17. Indicator Light for TV |
| 7. PLAY/PAUSE | 18. VIDEO IN |
| 8. STOP | 19. AUDIO IN L. |
| 9. PREVIOUS/CH- | 20. AUDIO IN R. |
| 10. NEXT/CH+ | 21. IR |
| 11. VOLUME DOWN | 22. RESET BUTTON |

Back View

NTSC System

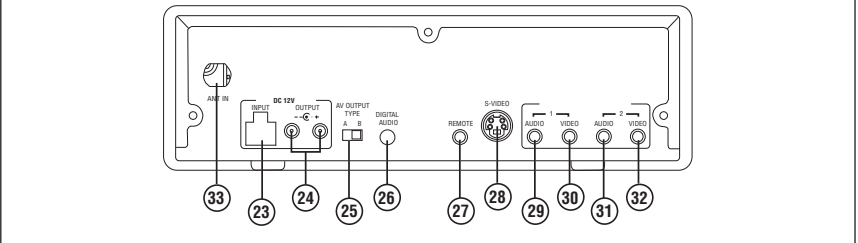

- | | |
|---------------------------|--------------------|
| 23. DC 12V INPUT socket | 29. AUDIO OUTPUT 1 |
| 24. DC 12V OUTPUT socket | 30. VIDEO OUTPUT 1 |
| 25. AV OUTPUT TYPE switch | 31. AUDIO OUTPUT 2 |
| 26. DIGITAL AUDIO | 30. VIDEO OUTPUT 2 |
| 27. REMOTE socket | 33. ANT IN |
| 28. S-VIDEO socket | |

Installation

Note:

1. First remove the two screws that lock the player mechanism (see figure below). Then attach the brackets on both sides of unit with the M4x5 screws. Next, install the unit with the M5x25 screws.
2. When mounting the unit, slide the screws to the left or right side to meet desired position. Select position 1 and 3, or 2 and 4 to mount the bracket.

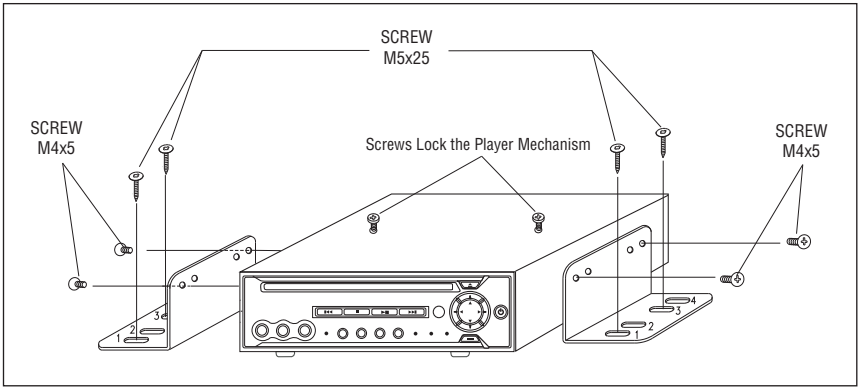

Electric Connection

Connecting to a VCR as an Auxiliary Source

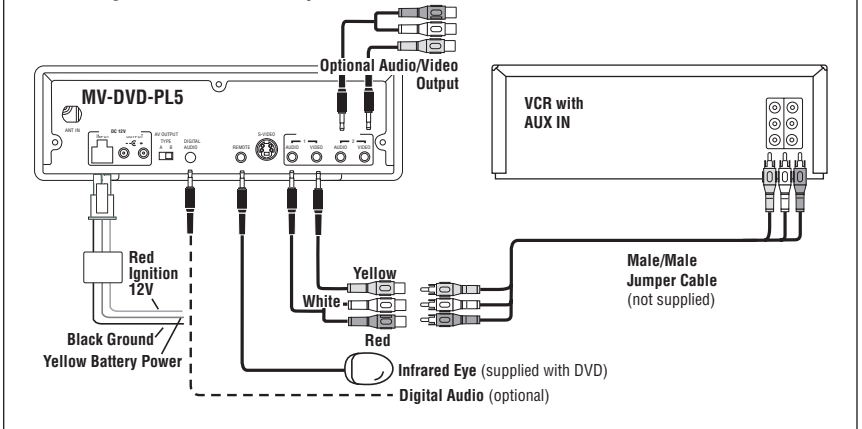

Electric Connection

Connecting to a MovieVision Systems as the Only Source

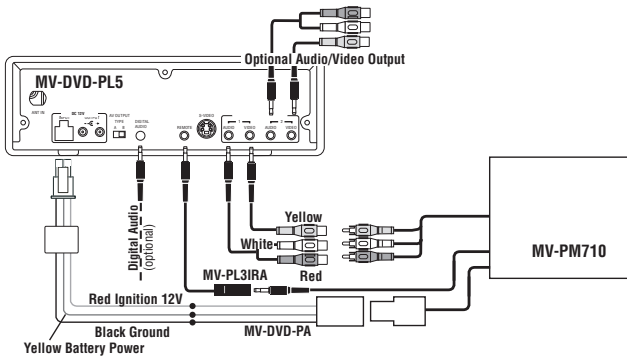

Connecting to a MovieVision System as the Second Source

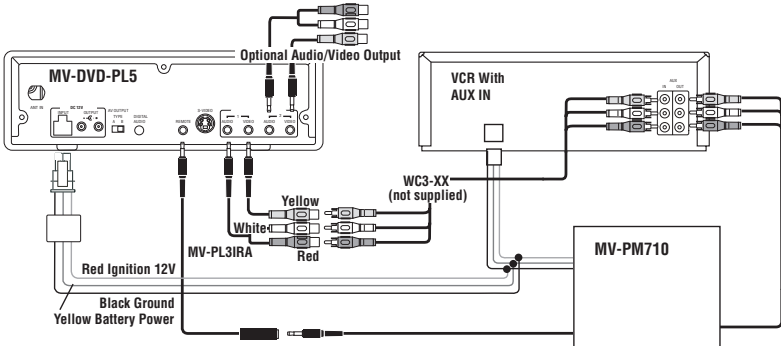

Note:

- The **S-Video** output is only effective on **DVD**, not on **AV1** and **AV2**.
- Slide **AV OUTPUT TYPE** switch on the back of the unit left or right to select **A** or **B**. When the switch is set to **A**, the **AV OUTPUT 1** and **AV OUTPUT 2** are both under the Control of the **MODE** button on the remote or the **SOURCE** button on

the front panel of the unit. When the switch is set to **B**, the **AV OUTPUT 1** will only output the **AV INPUT 1** signal and cannot be controlled using the **MODE** or **SOURCE** buttons. However, the signal output from **AV OUTPUT 2** can be accessed using the **MODE** or **SOURCE** button or the volume up/down buttons.

Remote Control

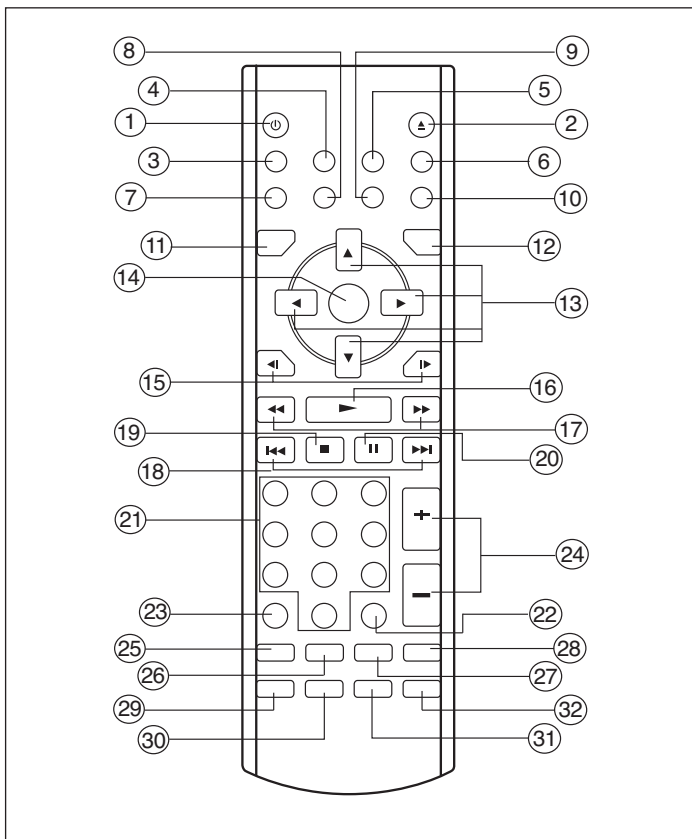

Preparing/Using the Remote Control

Preparing the Remote Control

















Inserting the Batteries:

1. Open the battery compartment cover.
2. Insert the two AAA size batteries. Make sure that the positive and negative terminals of the batteries are oriented correctly.
3. Close the battery compartment cover.

Using the Remote Control

Point the remote control towards the remote infrared sensor (IR).

Remote Control Functions

- POWER:**  Turns the unit ON or OFF.
- EJECT:**  Ejects the disc.
- MUTE:** Mutes the sound.
- SUBTITLE:** Changes the SUBTITLE language on multi-subtitle language DVD disc.
- ANGLE:** Changes the view angle on multi-angle DVD disc.
- CONSOLE:** Displays statistical disc information during playback.
- MODE:** Changes between DVD, TV and AV mode.
- SETUP:** Displays the SETUP menu.
- PAL/NTSC:** Switches between PAL and NTSC mode.
- AUDIO:** Changes the AUDIO soundtrack on multi-audio soundtrack DVD disc.
- TITLE:** Displays the TITLE menu that is stored on the DVD disc.
- MENU:** Displays the root menu that is stored on the DVD disc. In TV mode, use it to enter search mode. Press  to search TV channels.
- NAVIGATION:** In MENU mode, , , ,  buttons serve as cursor buttons to select item left/right, forward/back.
- ENTER:** Confirms the Track/Chapter selected with the numeric buttons or selected with the cursor buttons on TV screen.
- SLOW FW/RV:**   Slow FORWARD/REVERSE playback motion.
- PLAY:**  Plays the disc.
- RAPID FW/RV:**  Searches FORWARD rapidly.  REWINDS rapidly.
- SKIP:**  Skips forward one track.  Skips back one track.
- STOP:**  STOPS Play.
- PAUSE:**  PAUSES Play.
- 0-9:** Numeric buttons.
- 10+:** Digital selection button, used in combination with numeric buttons.
- CLEAR:** Clears number when input in error.
- VOLUME:** **VOLUME+/-** Increases or decreases the volume level.
- ZOOM:** Enlarges or reduces size of picture.
- BOOKMK:** Press to enter bookmark function during playback.
- GOTO:** Goes to the bookmark that you selected.
- PBC:** Change between PBC On and PBC Off on the VCD Disc.
- RANDOM:** Plays tracks in RANDOM order.
- PROGRAM:** Plays tracks in the order programmed.
- REPEAT:** Switches the REPEAT mode of discs.
- A-B:** Allows a passage to be repeated continuously.

Basic Operation

Turn the Unit On

1. Turn the car ignition on to the accessory position.
2. Press the **POWER**  button.



Loading a DVD/VCD/CD Disc

1. Insert the disc with printed side facing up into the disc slot. The player will automatically search the disc.
2. The player starts playback automatically.

Ejecting a Disc

Press the  **EJECT** button to eject disc.

Standby

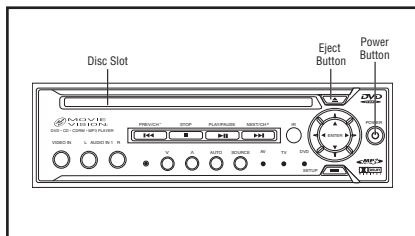

1. With the unit on, press **POWER**  on the remote.
2. In standby state, press **POWER**  on the remote, again to recall playback.
3. To cancel standby state, press **POWER** on the unit's front panel.

Note: For Screen Saver mode select "On" in Screen Saver setup. The screen saver will automatically activate when playback is stopped or paused and there is no button operation for 5 minutes. Screen saver mode will release automatically when a disc is played. After 5 minutes, if the unit is not operated while in screen saver mode, it will enter standby state.







BASIC PLAY

Stopping Play



Press the  **STOP** button to stop the disc playback. Press the  **PLAY** button on the remote or  on the player, the disc will continue with normal playback.

Press the  **STOP** button twice, to stop the playback and go back to initial Track/Chapter.

Pause (still picture)

Press **PAUSE**  during playback on the remote or  on the front panel of the DVD unit to stop play temporarily. Press **PLAY**  on remote or  on the unit to return to normal playback.

Rapid Forward/Rapid Reverse

Press **FF**  and **REW**  during play. Each time the button is pressed, the speed of rapid forward/reverse changes according to the disc as follows:

DVD:

Normal Playback → 2X → 4X → 16X → 100X

VCD/CD/MP3:

Normal Playback → 2X → 4X → 8X

Slow Motion Play (DVD Only)

Press **SLOW**  on the remote control during playback. Each time the button is pressed, the slow mode is changed according to the disc as follows:

DVD:

→ 1/32X → 1/16X → 1/8X → 1/2X

Skipping Track

Press **SKIP** ◀◀/▶▶ on the remote control or on the front panel during playback. Press ▶▶ to skip to next track and ◀◀ to go back one track.

Note: For some VCD 2.0 (PBC-playback control), may be unavailable.

Mute

Mutes the sound, while the disc continues playing. When **MUTE** is pressed again, sound will resume at previous level.

Volume Level Adjustment

Press ^/v on the front panel of the unit or **VOLUME +/-** on the remote to increase or decrease volume level.

DVD Video Menu

When playing a DVD disc in the player:

1. Disc will play automatically and stop at menu display.
2. Use **NAVIGATION** ◀/▶, ▲/▼ buttons on the remote to and move the highlight bar in the menu
3. Press **ENTER** to confirm selection.

Mode Selection

Press **SOURCE** on the front panel of the unit or **MODE** on the remote to select among DVD, TV and AV mode The indicator on the front panel of the unit will illuminate with the corresponding selection.

Reset

The **RESET** button is on the front panel of the unit and must be activated with a ball point pen or thin metal object. This button is to be activated only for the following reasons:

- After the initial wiring installation of the unit is complete.
- All the function buttons are not operating correctly.
- An error symbol is displayed.

Last Play Memory

Press **POWER** ⏻ during play to turn "Off" the unit. Press again to turn "On" the player. The DVD player will resume playing from the point that it stopped.

- While the disc is playing, press **EJECT** to eject the disc, then reload the disc into the player again, the player will resume playing from the point that it stopped.
- While the disc is playing press **SOURCE** or **MODE** to switch to TV or AV mode. The player will resume playing from the point that it stopped.

Advanced Operation

Repeat Play/Repeat Paragraph Play:

Repeat Play

Press the **REPEAT** button to repeat a disc, track or chapter.

1. Press **REPEAT** button repeatedly to scan selection of repeat modes.
2. Pressing **REPEAT** will have different effects on various kinds of discs.

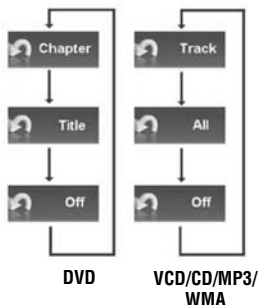

Note: REPEAT feature does not support VCD2.0 with PBC "On".

Repeat Paragraph

A-B repeat allows a passage to be repeated continuously.

1. Press A-B button at the start of the required passage.



2. Press A-B button again at the end of the passage.



3. The unit will repeat playing the passage set from **A** to **B**.

4. To revert to normal playing press **A-B** button again.



On Screen Display Function

Press the **CONSOLE** button during playback to display the console information of the current disc onscreen.

For DVD:



1. Item: Title

Function: Displays the current Title number and total Title number; use it to skip to the desired Title number.

Method: ◀/▶, buttons or numeric buttons to input. Press **ENTER** button to confirm.



2. Item: Chapter

Function: Displays the current chapter number and total chapter number. Use it to select the desired chapter number.

Method: ◀/▶, buttons or numeric buttons to input. Press **ENTER** button to confirm.



Advanced Operation

3. Item: Time

Function: Displays the elapsed time. Input the time directly to skip to the corresponding playback point.

Method: Use numeric buttons to input time. Press **ENTER** button to confirm.



4. Item: Audio

Function: Displays the current Audio Soundtrack Language and Digital Audio Output. Use it to select other Audio Soundtrack Languages and Digital Audio Output.

Method: ◀/▶ buttons or press **AUDIO** button.



5. Item: Subtitle

Function: Displays the current subtitle language. Use it to select other subtitle languages.

Method: ◀/▶ buttons or press **SUBTITLE** button.



6. Item: Angle

Function: Displays the current angle. Use it to select other angles.

Method: ◀/▶ buttons or press **ANGLE** button.



7. Item: Sound

Function: Displays the current sound mode. Use it to select from normal and 3D surround mode.

Method: ◀/▶ buttons or **3D** button.



PAL/NTSC System Selection

Press the **PAL/NTSC** button to switch between **PAL**, **NTSC** and **AUTO** modes.

NOTE: This function is only effective when **LOGO** is displayed. For instance, when there is no disc in the unit, ejecting a disc and in the **STOP** mode or pre-**STOP** mode when playing a DVD/VCD.

Bookmark Function

Press **BOOKMK** button while playing disc to enter **BOOKMK** mode.

1. During playback press **BOOKMK** button to set desired bookmark. The screen will display (as shown) that you have set a bookmark.



2. To view the selection that you bookmarked, press the **GOTO** button, then press ◀/▶ buttons to move cursor to the desired bookmarked number. Press ▶ or **ENTER** button to confirm.



Random Playing

Press the **RANDOM** button during playback to play tracks in random order. Press **RANDOM** again to revert to normal playback.

Note:

- This function is effective on VCD, and CD.

Zoom

For DVD and VCD to enlarge an area on the screen.



1. Press the **ZOOM** button. This will zoom in up to 4 times.

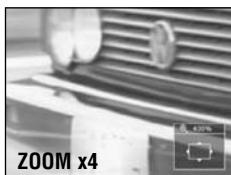

2. Press the **ZOOM** button again. This will zoom in up to 16 times.

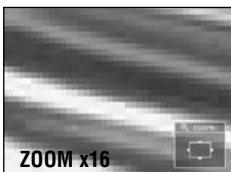

3. In **ZOOM** mode press ◀/▶, ▲/▼ buttons to move images up, down, left or right to find the desired image to zoom in on.

4. To cancel zoom press **ZOOM** again when it is at 16 times.

SPECIAL FUNCTIONS FOR DVD

Multi-Subtitle Language Function

Press **SUBTITLE** during playback. Each time the button is pressed the subtitle language changes.



Multi-Audio Language Function

Press **AUDIO** during playback. Each time the button is pressed, the audio soundtrack language changes in sequential order.



Multi-Angle Function

Press **ANGLE** during playback. Each time the button is pressed, the angle soundtrack language changes in sequential order.



PARENTAL CONTROL

Instructions:

Press **TITLE** button, when there is no disc in the player, then press 0,1,6,7. The screen will read:



For Example: Input 2, then press **ENTER** to exit. The setting and the picture will disappear. Press **TITLE** button, then press 0,1,6,7 again and the following information will appear on the screen. Now you can edit another code.



When a DVD disc is inserted that has a **PARENTAL CONTROL** level higher than the level set to the DVD player a window will display that requires entering a 4 character password.

Note:

- The factory setting password is 3351. If you have forgotten or lost the password enter 3351.

Parental Control Summary

• DVD discs have a **PARENTAL CONTROL** assigned to the disc. The range of **PARENTAL CONTROL** is from 1 to 8. The player can be set in a similar way.

- For instance, if there is a parental level set to 8, it will play all discs. If the player's parental level is set below 8, only discs with a lower or equal parental level will play. For example if the player is set to 5, only discs with parental control ratings of 5, 4, 3, 2, & 1 will play.

- To play a higher rated disc you must change the player's level rating to a higher number.

- Some discs, that generally are suitable for most audiences are rated at level 2. However, there might be scenes, included on the disc, rated 5 or 7 (not suitable for children).

- Alternative scenes with lower rating are included on the disc. The unit will play the highest rated scene that the parental setting allows. A section of the disc can have several different sequences that vary in **PARENTAL CONTROL** level. The player will choose the appropriate section depending on the parental control level set in the player's menu.

- This allows parent(s) control of the content of discs without any indication that censorship has occurred.

- The meaning of the levels 1 to 8 varies depending upon the country and the type of content on the disc.

PARENTAL CONTROL LEVELS	
	Unlock
1	Kid Safe
2	G
3	PG
4	PG-13
5	PG-R
6	R
7	NC-17
8	Adult



DATA DISC & AUDIO CD PLAY OPERATION

Insert a data disc (MP3, WMA, MPEG, JPG or audio CD).

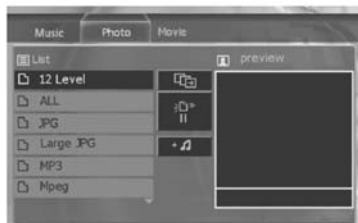

1. Press **TITLE** button to switch between music, photo and movie pages.
2. There are three areas in the music page: Play List, Program List and Edit.
 - Press **PLAY** ► or **ENTER** to open the highlighted folder in the play list or play an audio file in the Play List or Program List.
 - Use the operation buttons such as: ADD, ADD ALL, DELETE, AND DELETE ALL in the middle Edit area to edit the Program List.
 - Press **PROGRAM** button to add the highlighted file directly to the program list when the audio file is highlighted in the Play List.
 - Press **CLEAR** button to delete the highlighted file in the Program List.
3. Choose from three areas in the Photo Page: Play List, Preview Window and Edit.



- Press **PLAY** ► or **ENTER** to open the highlighted folder in the Play List.
 - A preview of the picture will be displayed in the preview window on the right when the highlight bar stops on the picture file.
 - Select Slide Show button  in the middle area. Press **ENTER** to confirm. The images will play full screen in order and the control bar will display on the screen.
- 3/15 ◀◀ 90° ▶▶ 90° ▲Prev ▼Next ■Stop ⌵Hide
4. In Movie Page, Press **ENTER** button to open the highlighted folder in the Play List or play the corresponding file.
 - Press ◀ or ▶ button to skip to the previous or next picture.
 - Select the Mixed Play button  in the middle area and press **ENTER** to confirm.
 - Select the Speed button  to adjust the display interval speed between pictures. Press ◀/▶ buttons to switch between >, >>, >>> and || .

Note: For an audio CD, the play interface and operation is similar to the Music Page operation.

Setup



In the **STOP** ■ mode or while disc is playing, press **SETUP** on the remote or front panel of unit to enter setup menu.

- When the cursor is on the topside, use ◀/▶ buttons to move between different pages.
- Press ▼ button to move the cursor to the Setup Page (shown below). Use the ▲/▼ buttons to move between different setup options.
- Press ▶ button to display the choice list for each setup option and then use ▲/▼ buttons and **ENTER** button to make selection.

LANGUAGE SETUP

Open the Setup menu.



- Menu Language is used to change the language throughout the entire menu and prompt information during playback. Choose a language from the list.

- Disc Audio sets the preset value for the language playback of a DVD. If the DVD and the preset value on the DVD player match then it will play that language directly. When the player and disc do not match then, the disc will play its default language.

NOTE: The unit has the following selection of languages: Original, English, Spanish, German, Italian, French, Portuguese, Russian, Chinese and others.



- Disc Subtitle and Disc Menu are similar to Disc Audio. The function of Disc Audio is to set a preset value for the playback subtitle and menu display language of the DVD.

DISPLAY SETUP

Open the Display Menu.

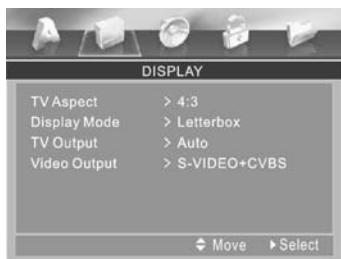

- TV Aspect sets the appropriate display effect when wide-screen video material is played on a conventional screen. Choose from two options: 4:3 and 16:9.
- If Display Mode is set to 4:3 in the TV Aspect you can choose from Letterbox and Panscan modes.
 - Panscan: Displays the picture in TV mode with the left and right edges of screen cut off.
 - Letterbox: Displays the picture in cinema mode with black bands across the top and bottom of screen.
- When TV Output is selected it will output in TV mode. The unit can play discs recorded in either PAS or NTSC format.
 - Select NTSC to connect to a NTSC TV.
 - Select PAL to connect to a PAL TV.
 - Select Auto format to automatically format to the DVD disc format.
- For Video Output there is only one video output mode S-VIDEO = CVBS.

AUDIO SETUP

Open the Audio Menu.



- Dolby Digital refers to dolby digital output.
 - Bitstream: Choose this when using the Dolby Digital Decoder, DTS Decoder or MPEG Decoder, etc, to connect to an amplifier or other devices
 - PCM (Pulse Code Modulation): Select PCM when connecting to an amplifier with two channel digital stereo. When playing a DVD disc with Dolby Digital which was recorded by MPEG1 or MPEG2 the DVD player will output the audio in PCM2 playback mode.
- In DTS (Date Transmission System) there are two choices: Bitstream and PCM.
- Choose On or Off for DRC (Dynamic Range Control). In On mode you can listen to the film sound effects at lower volumes without losing the sound definition.
- Choose Digital Output to activate the digital audio output On or Off.

LOCK SETUP

Select the Lock Setup page.



- Access the Parental Control level from Rating
 - After entering Rating, the system will require a password. Once the correct password is entered you will be permitted to the change the parental lock level.
 - If no password has been set, the system will require you to set a password.
 - If you incorrectly enter a character while setting the password press CLEAR to delete the character.
 - Once the correct password is entered you can use ▲/▼ buttons to make changes to the Parental level.
 - Choose from 9 levels of control. (See PARENTAL CONTROL)
- After completing the setup menu, you must eject and then reload the disc in order for the functions to take effect.
- Password setup sets the new password or change the current password. Before entering into this field the system requires you to input the current password.

- Country Code sets the nations code. If the country code matches the discs country code, the parental level will take effect. This is a two digit code.
 - Before entering into this field the system will require a password.
 - Use ▲/▼ buttons to select the first character.
 - Use ► button to move the cursor.
 - Use ▲/▼ buttons to select the second character.
 - Press **ENTER** to confirm the selection for country code.

OTHERS SETUP

Select the Others Setup page.



- In this mode you can choose between the settings Load Default and Screen Saver.
- To revert to factory settings choose Load Default.
 - To switch the screen saver function On or Off choose Screen Saver.

TV Operation

LANGUAGE SETUP

To access the TV Mode press the **MODE** button on the remote. The DVD functions are locked during TV Mode.

Searching Channels

Press MENU (TV SEARCH) button on the DVD player front panel or MENU on remote to enter into search mode. On the remote press ►► button to auto search and store TV channels. Press ◄◄ button to stop the search.

Selecting Channels

1. Press ►► (CH+) button or ◄◄ (CH-) button to select a channel up or down.
2. The numeric buttons (0-9) allow you to select the corresponding channel.
3. Press the digital select button 3D(---) and a numeric button to select desired channel.

Volume Adjustment

Press ▲/▼ on the front panel of the DVD player or VOLUME +/- buttons on the remote to adjust the volume level.

Mute

Press the MUTE button to mute the sound. Press the MUTE again or volume up/down buttons on the front panel of the unit or remote for sound to resume.

Specifications

Supply Voltage	12V DC, Negative Ground
Current Consumption	Less than 2A
Signal System	Composite Video 1.0Vp-p 75Ω
Compatible Discs	(1) DVD-VIDEO Disc, 5" (12cm) Single-Sided Single-Layer, 5" (12cm) Single-Sided Double-Layer, (2) Compact Disc (CD-DA, Video CD), 5" (12cm) Disc
Audio Output Level.	2 CH 2.0 Vrms @10kΩ
Characteristics	(1) Frequency Response: 20 Hz - 20 KHz, (2) Signal to Noise Ratio: 80dB (JIS) (3) Wow and Flutter: Below Measurable Limits

Troubleshooting

Only qualified service personnel can remove the cover or service this player. Otherwise the warranty will become invalid.

No Power:

- Check to see if the player is set to "On".
- Check to see that the power plug of the main unit is properly connected.
- Check to see if that power to the outlet is properly working.

No Picture:

- Check to see that the monitor or TV is switched to "On".
- Select the correct AV input on the monitor or TV.
- Check the video connection.

Distorted Picture:

- Check the disc for fingerprints and clean with soft, dry, cloth, wiping from center to edge.
- A small amount of picture distortion may appear. This may not be a malfunction.

Completely Distorted Picture:

The disc format is not according to the TV used (PAL/NTSC).

No Color in Picture:

The disc format is not according to the TV used (PAL/NTSC).

No Sound:

- Check audio connections.
- If using a Hi-Fi amplifier, try another sound source.

Disc Does Not Play:

- Ensure the disc label is facing upwards.
- Clean the disc.
- Check to see if the disc is defective by trying another disc.

No Return to Start-Up Screen when Disc is Removed:

- Press **POWER** to turn "Off" the unit, then press it again to turn "On" the unit.
- Press **RESET** button "On" the front of the DVD unit.

The Player Does Not Respond to the Remote Control:

- Aim the remote control directly at the sensor on the front of the player.
- Avoid all obstacles which may interfere with the signal path.
- Inspect or replace the remote control batteries.

No Audio at Digital Output:

- Check the digital connections.
- Check the Audio Setup menu to make sure that the digital output setting is correct.
- Check if the audio format of the selected audio language matches your receiver's capabilities.

Buttons Do Not Work:

- Press **POWER** to turn "Off" the unit, then press it again to turn "On" the unit.
- Press **RESET** button on the front of the DVD unit.

DVD player showing "REGION ERROR"

- The DVD player and the discs all have a "REGION CODE". If the region number on the disc does not correspond to the region number of the DVD player the unit cannot play the disc.

Replacement Parts Order Form

Send Orders To: Magnadyne Corporation
 ATTN: Consumer Parts Sales
 P.O. Box 5365
 Carson, CA 90749-5365

We Accept Checks, Money Orders, Visa and Master Card
Make Checks Payable to: Magnadyne Corporation

SHIP TO: (No P.O. Boxes)

_____ | _____ | _____
LAST NAME

_____ | _____ | _____
FIRST NAME

INITIAL

STREET ADDRESS (IF PAYING WITH A CREDIT CARD, YOUR BILLING ADDRESS IS REQUIRED)

CITY

STATE

ZIP CODE

DAYTIME PHONE NUMBER

CREDIT CARD INFORMATION:

CARD TYPE: VISA MASTER CARD

CARD NUMBER

EXP. MONTH

YEAR

NAME - EXACTLY AS IT APPEARS ON YOUR CREDIT CARD

Part #	Description	Qty.	Price Each	TOTAL
MV-2000RM	Remote Control		\$39.95	

Shipping and Handling

Subtotal + Tax	Add
Up to \$20.00	\$5.00
20.01 to 30.00	5.95
30.01 to 45.00	6.50
45.01 to 70.00	6.95
Over 70.01	7.95

Subtotal = _____ . _____

California Residents Add Sales Tax = _____ . _____

Shipping and Handling (See Chart) = _____ . _____

TOTAL = _____ . _____

No C.O.D.'s

On regular orders please allow 4-5 weeks for delivery. Please give a shipping address where this order may be delivered between the hours of 9 a.m. and 5 p.m. weekdays. If UPS is unable to deliver, your order will be returned and additional shipping charges will be required.

Replacement Parts for MovieVision® Systems

ORDER BY MAIL	DESCRIPTION	MODEL #	PRICE
	DVD Remote Control	MV2000RM	\$39.95 EA.

Warranty

ONE (1) YEAR LIMITED WARRANTY

Magnadyne Corporation or its authorized agents will within 1 year from the date of sale to you, repair, replace or refund the retail sales price of said product or any part thereof, at the option of the Magnadyne Corporation or its authorized agents, if said product or part is found defective in materials or workmanship, when properly connected and operating on the correct power requirements designated for the specific product. This warranty and Magnadyne Corporation or its authorized agents obligations hereunder do not apply where the product was; damaged while in the possession of the consumer, subjected to unreasonable or unintended use, not reasonably maintained, utilized in commercial or industrial operations, or serviced by anyone other than Magnadyne Corporation or its authorized agents, or where the warning seal on the product is broken or the power and/or plugs are detached from the unit. Magnadyne Corporation or any of its authorized agents will not assume any labor costs for the removal and re-installation of any product found to be defective, or the cost of transportation to Magnadyne Corporation or its authorized agents. Such cost are the sole responsibility of the purchaser.

This warranty does not cover the cabinet appearance items or accessories used in connection with this product, or any damage to recording or recording tape, or any damage to the products resulting from improper installation, alteration, accident, misuse, abuse or acts of nature.

MAGNADYNE CORPORATION OR ITS AUTHORIZED AGENTS SHALL NOT BE LIABLE TO ANYONE FOR CONSEQUENTIAL OR INCIDENTAL DAMAGES OR CLAIMS EXCEPT THOSE ACCORDED BY LAW. NO EXPRESSED WARRANTY OR IMPLIED WARRANTY IS GIVEN EXCEPT THOSE SET FORTH HEREIN. NO IMPLIED WARRANTY SHALL EXTEND BEYOND 1 YEAR FROM THE DATE OF SALE.

This warranty extends only to the original purchaser of the product and is not transferable.

Some states do not allow limitations on how long an implied warranty lasts and some states do not allow the exclusion or limitation of incidental or consequential damages, so the above limitations or exclusion may not apply to you. This warranty gives you specific legal rights and you may have other rights that vary from state to state.

Defective merchandise should be returned to the original point of purchase or secondly, to Magnadyne Corporation, 1111 W. Victoria Street, Compton CA 90220. Return Authorization must be obtained before sending, or merchandise may be refused.

